

WORX

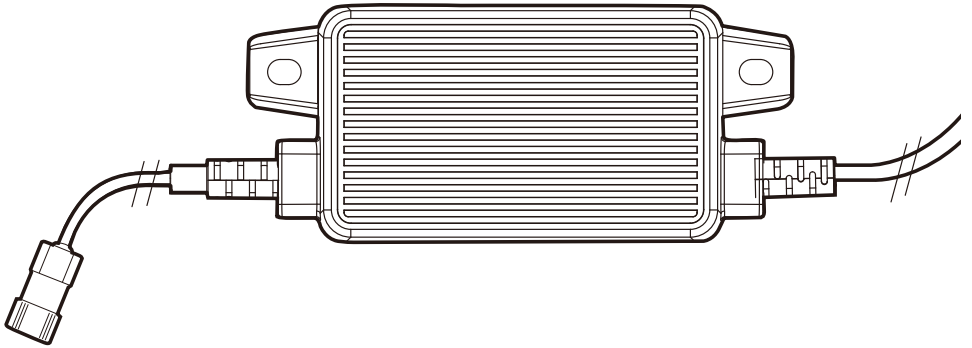

WA3755

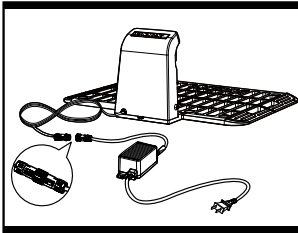

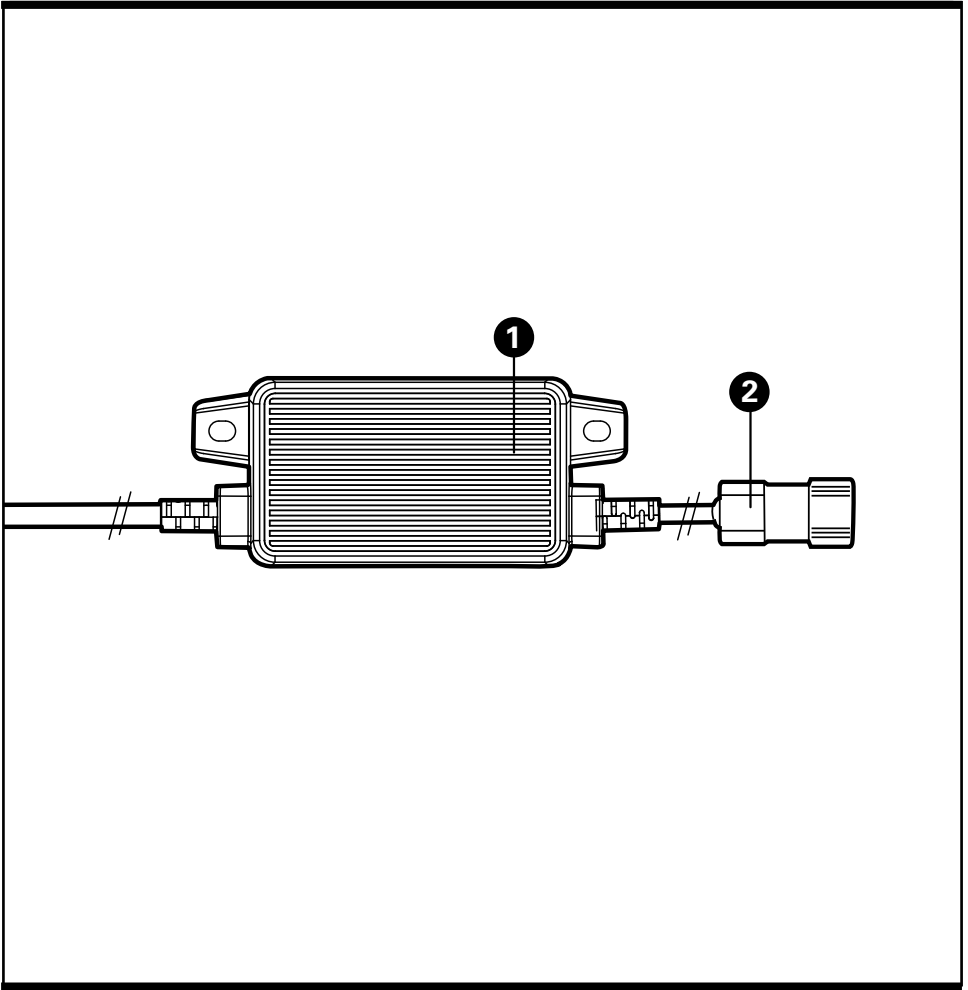

A

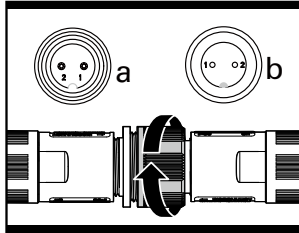

B

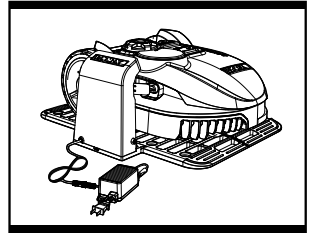

C

1. Power adaptor

2. Connector

Not all the accessories illustrated or described are included in standard delivery.

We recommend that you purchase your accessories from the same store that sold you the tool. Refer to the accessory packaging for further details. Store personnel can assist you and offer advice.

TECHNICAL DATA

Charger voltage	100-240 V~50/60 Hz
Power input	38W
Output voltage	20V $\overline{\text{---}}$ 1.5 A
Charging time (approx.)	
2.0Ah	1.5h approx.
2.9Ah	2.0h approx.
Number of cells	5
Machine weight	0.3kg
Protection class	

For the technical data of the types, the number of cells and the rated capacity of the batteries that can be charged, please refer the nameplate of the battery pack supplied by WORX.

PRODUCT SAFETY GENERAL SAFETY WARNINGS

 **WARNING: Read all safety warnings and all instructions.** Failure to follow the warnings and instructions may result in electric shock, fire and/or serious injury.

Save all warnings and instructions for future reference.

This appliance can be used by children aged from 8 years and above and persons with reduced physical, sensory or mental capabilities or lack of experience and knowledge if they have been given supervision or instruction concerning use of the appliance in a safe way and understand the hazards involved. Children shall not play with the appliance. Cleaning and user maintenance shall not be made by children without supervision.

If the supply cord is damaged, it must be replaced by the manufacturer, its service agent or similarly qualified persons in order to avoid a hazard.

ADDITIONAL SAFETY INSTRUCTIONS FOR YOUR BATTERY CHARGER

1. Before charging, read the instructions.
2. After charging, disconnect the battery charger from the supply mains. Then remove the chassis connection and then the battery connection.
3. Do not charge a leaking battery.
4. Do not use chargers for works other than those for which they are designed.
5. Before charging, ensure your charger is matching the local AC supply.
6. For indoor use, or do not expose to rain.
7. The charging device must be protected from moisture.
8. Do not use the charging device in the open.
9. Do not short out the contacts of battery or charger.
10. Respect the polarity "+/-" when charging.
11. Do not open the unit and keep out of the reach of children.
12. Do not charge the batteries of other manufactures or ill-suited models.
13. Ensure that the connection between the battery charger and battery is correctly positioned and is not obstructed by foreign bodies.
14. Keep battery charger's slots are free of foreign objects and protect against dirt and humidity. Store in a dry and frost-free place.
15. When charging batteries, ensure that the battery charger is in a well-ventilated area and away from inflammable materials. Batteries can get hot during charging. Do not overcharge any batteries. Ensure that batteries and chargers are not left unsupervised during charging.
16. Do not recharge non-rechargeable batteries, as they can overheat and break.
17. Longer life and better performance can be obtained if the battery pack is charged when the air temperature is between 18°C and 24°C. Do not charge the battery pack in air temperatures below 4.5°C, or above 40.5°C. This is important as it can prevent serious damage to the battery pack.
18. Charge only battery pack of the same model provided by WORX and of models recommended by WORX.

SYMBOLS



Read the operator's manual.



Warning



For indoor use only



Double insulation



Fuse



Positive terminal



Negative terminal



Waste electrical products must not be disposed of with household waste. Please recycle where facilities exist. Check with your local authorities or retailer for recycling advice.

CHARGING PROCEDURE



NOTE: Before using the charger, read the instruction book carefully.

HOW TO USE YOUR CHARGER

1. Plug charger directly into an electrical outlet. **DO NOT ABUSE THE CORD.** Never carry charger by cord. Do not disconnect the charger from the outlet by pulling it by the cord.
2.  **CAUTION:** To reduce the risk of fire, electrical shock, or personal injury do not attempt to use this charger with any other product. Likewise, do not attempt to charge the mower with any other charger.
3. Do not operate a damaged charger. Replace damaged cords or charger immediately at an authorized WORX service depot.
4. Do not charge in wet locations. Do not charge mower when temperature is above 104°F (40°C) or below 41°F (5°C).

5. Keep the mower and charger away from water, heat sources, (such as radiators, heaters, stoves...etc.) flames, or chemicals. Be careful not to damage the charger cord, by keeping cord away from sharp edges.

CONNECTING THE CHARGING STATION (See Fig. A, B)

1. Connect the low voltage cable of the charging station to the charger. When connecting, align the notch on the power cord connector (a) with the groove on the adaptor connector (b). The connectors may be slightly difficult to connect, as they are moisture-proof, tighten the connectors firmly.
2. Connect the charger's power cord to a wall socket. It is preferable to use an earth-fault breaker as recommended.

CHARGING A DISCHARGED BATTERY (See Fig. C)

When WORX Landroid® is new or has been stored for a long period, the battery will not be charged and needs to be charged before starting. Charging takes between 1 and 2 hours.

- 1) Place Landroid® in the charging station. Insert the mower as far as possible. (See C)
Good contact is made when both the charging strips on the mower touch the centre of the contact strips on the charging station.
- 2) Open the control panel cover. Press on/off button to start, and press Home button.
- 3) Close the control panel cover. The charging base red light will turn on, while "charging" is shown on the screen.

MAINTENANCE

Remove the plug from the socket before carrying out any adjustment, servicing or maintenance. Your charger requires no additional lubrication or maintenance. Never use water or chemical cleaners to clean your charger. Wipe clean with a dry cloth. Always store your charger in a dry place.

ENVIRONMENTAL PROTECTION

 Waste electrical products must not be disposed of with household waste. Please recycle where facilities exist. Check with your local authorities or retailer for recycling advice.

PLUG REPLACEMENT (UK & IRELAND ONLY)

If you need to replace the fitted plug then follow the instructions below.

IMPORTANT

The wires in the mains lead are colored in accordance with the following code:

Blue - Neutral

Brown - Live

As the colors of the wires in the mains lead of this appliance may not correspond with the coloured markings identifying the terminals in your plug, proceed as follows. The wire which is coloured blue must be connected to the terminal which is marked with N. The wire which is coloured brown must be connected to the terminal which is marked with L.

WARNING: Never connect live or neutral wires to the earth terminal of the plug. Only fit an approved BS1363/A plug and the correct rated fuse.

NOTE: If a moulded plug is fitted and has to be removed take great care in disposing of the plug and severed cable, it must be destroyed to prevent engaging into a socket.

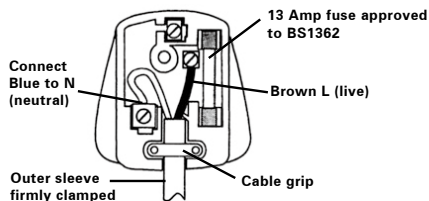

DECLARATION OF CONFORMITY

We,
POSITEC Germany GmbH
Konrad-Adenauer-Ufer 37
50668 Köln

Declare that the product,
Description **WORX Battery Charger**
Type **WA3755**

Complies with the following Directives,
2014/35/EU
2014/30/EU
2011/65/EU

Standards conform to

EN 60335-1
EN 60335-2-29
EN 62233
EN 55014-1
EN 55014-2
EN 61000-3-2
EN 61000-3-3



Suzhou 2016/12/16
Allen Ding
Deputy Chief Engineer, Testing & Certification



www.worx.com

Copyright © 2016, Positec. All Rights Reserved.